



audio-technica

■ 特色

- 為合唱團、會議室及其他集會場所提供理想、經濟實惠的解決方案
- 四枚膠囊型可調式麥克風陣列，專為搭配 ATDM-0604 Digital SMART MIX™ 和其他相容混音器使用所設計
- 使用相容混音器控制時，透過原始合成技術 (PAT)，可提供 360° 覆蓋無限次數 (由混音器通道計數綁定) 的虛擬超心形或心形拾音，能夠以 30° 的增量指引清楚地捕捉房間裡每個講者的聲音。
- 混音器控制的傾斜功能提供垂直調整選項，可適應不同高度的天花板
- 內含配備 RJ45 接頭和推式電線接頭的阻燃級 AT8554 天花板固定組件，安裝簡單又安全，附有抗震纜線，可穩固安置在吊頂柵格上
- 整合式邏輯控制的紅/綠 LED 環形燈，提供清楚的靜音狀態指示
- 低底雜訊的高輸出設計，提供強大、自然響亮的聲音重現
- 採用低反光白色塗料，與大多數環境中的天花板鑲板相襯
- 內含兩條 46 cm 分接纜線：RJ45 (母) 轉三個 3 針 Euroblock 接頭 (母)、RJ45 (母) 轉 3 針 Euroblock 接頭 (母) 和無終端接頭的 LED 導線
- 使用鎖定墊圈持續連接 1.2 m 纜線，可快速調整麥克風高度
- UniGuard™ RFI 屏蔽技術能有效消除外來射頻干擾 (RFI)
- 使用直流 11 V 至 52 V 幻象電源

■ 商標

- SMART MIX™ 是「鐵三角」股份有限公司在美國和其他國家註冊的商標。
- UniGuard™ 是「鐵三角」股份有限公司在美國和其他國家註冊的商標。

■ 簡介

感謝您購買本商品。使用前，請務必詳閱本使用說明書，確保以正確的方式使用本產品。

■ 安全上的注意事項

雖然本產品採用安全設計，但使用不當仍可能引起事故。為防範事故於未然，使用本產品時請務必遵守下記事項。

■ 本產品注意事項

- 請勿讓本產品受到強烈碰撞，以免故障。
- 請勿拆開、改造或嘗試修理本產品。
- 請勿在雙手潮濕時握持本產品，以免觸電或受傷。
- 請勿將本產品存放在日照直射處、暖氣設備附近，或存放在炎熱、潮濕或充滿灰塵的地方。
- 請勿將產品安裝在空調或照明設備附近，以免故障。
- 安裝完成之後，請勿對本產品施力過度或緊抓不放。

■ 接線

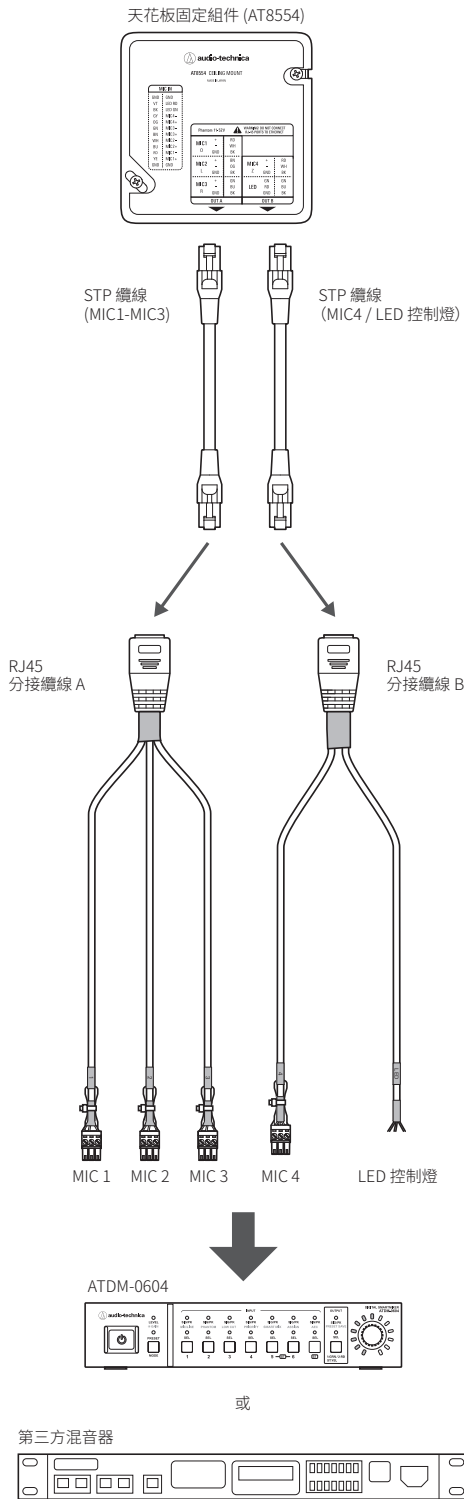

將麥克風的輸出端子連接到具有相容於幻象電源的麥克風輸入 (平衡輸入) 裝置上。
輸出端子為 Euroblock 接頭, 其極性如下圖所示。
使用 STP 纜線從安裝盒 RJ45 插孔連接到分接纜線。

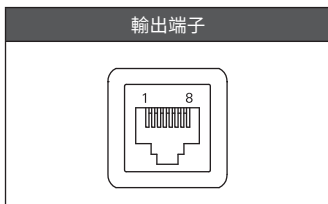

本產品需要直流 11V 至 52V 幻象電源以正常運作。

■ 佈線表

	RJ45 接頭針腳編號	功能	RJ45 分接纜線顏色
輸出 A	1	MIC2 L(+)	棕色
	2	MIC2 L(-)	橘色
	3	MIC3 R(+)	綠色
	4	MIC1 O(-)	白色
	5	MIC1 O(+)	紅色
	6	MIC3 R(-)	藍色
	7	GND	黑色
	8	GND	黑色
輸出 B	1	無	-
	2	無	-
	3	LED 綠燈	綠色
	4	MIC4 Z(-)	白色
	5	MIC4 Z(+)	紅色
	6	LED 紅燈	藍色
	7	GND	黑色
	8	GND	黑色

· 麥克風為低阻抗 (Lo-Z) 平衡輸出。訊號出現在 RJ45 分接纜線上每一成對的輸出 Euroblock 接頭。音訊接地為屏蔽連接。採用分階段輸出, 以便正聲壓在每個 Euroblock 接頭的左側產生正電壓。

· MIC1 是「O」(全指向), MIC2 是 240° 水平安置的「L」(八字形), MIC3 是 120° 水平安置的「R」(八字形), MIC4 是垂直安置的「Z」(八字形)。

■ 針腳指派

MIC 1		O+ O- GND
MIC 2		L+ L- GND
MIC 3		R+ R- GND
MIC 4		Z+ Z- GND
LED 控制燈		LED 綠燈 LED 紅燈 GND

■ LED 控制燈

- 若要控制 LED 環形指示燈，請將 RJ45 分接纜線的 LED 控制端子連接到自動混音器或其他邏輯裝置的 GPIO 埠。
- 當本產品搭配不具 GPIO 端子的混音器使用時，可將黑色 (BK) 或紫色 (VT) 導線連接到 GND 端子，讓 LED 環形燈保持恆亮。當黑色導線短路時，LED 環形燈將為綠色。當紫色導線短路時，LED 環形燈將為紅色。

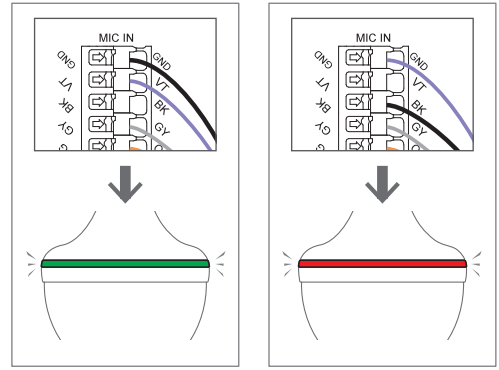
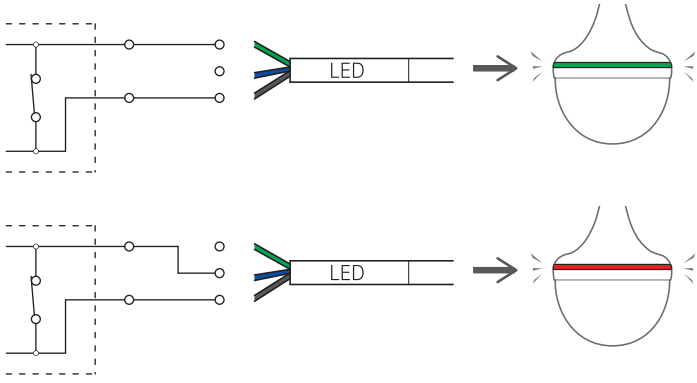

■ 零件、名稱和安裝

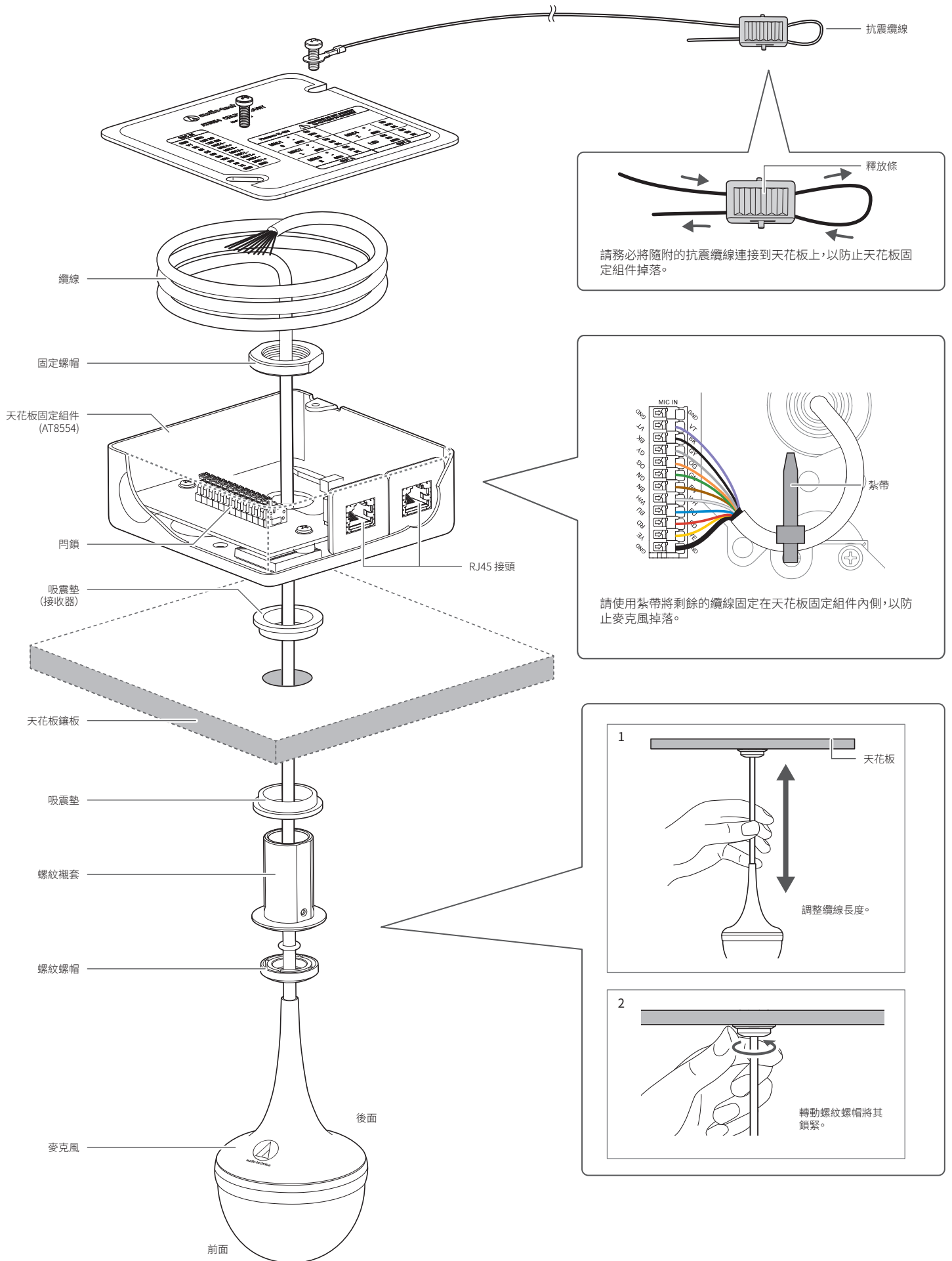

■ 注意事項

- 安裝本產品時，必須在天花板鑲板上挖一孔洞，才能將天花板固定組件固定就位。如果可以，請先卸下天花板鑲板。
- 若要在天花板鑲板上安裝螺紋襯套但不使用吸震墊：
需要 20.5 mm 直徑的孔洞，天花板鑲板的厚度上限為 22 mm。
- 若要使用吸震墊安裝螺紋襯套：
需要 23.5 mm 的孔洞，天花板鑲板的厚度上限為 25 mm。將吸震墊放置在孔洞兩側，以達到與安裝表面機械隔離的效果。

■ 安裝

1. 卸下天花板固定組件的背板，將其放置在天花板鑲板的背面，讓螺紋襯套能夠穿過。
2. 放置到位後，將固定螺帽旋入螺紋襯套，並將天花板固定組件鎖定在天花板鑲板上。
3. 壓下端子板上的橙色卡舌，將麥克風纜線連接到天花板固定組件上的端子接頭。
4. 完成所有連接後，使用隨附的紮帶將麥克風纜線固定在 PCB 上。
5. 經由天花板固定組件推拉纜線，將纜線調整到所需的麥克風高度。
6. 將麥克風放置到所需位置後，請小心地順時針旋轉螺紋螺帽以鎖定。(請勿鎖得太緊或用力拉扯纜線)。
7. 將多餘的纜線捲入天花板固定組件並裝回背板。

■ 建議的位置

根據使用本產品的所在環境更改高度和傾斜位置。

傾斜 \ 麥克風位置	最小高度	一般高度	最大高度
向上傾斜	1.2 m	1.75 m	2.3 m
向下傾斜	1.7 m	2.2 m	2.7 m

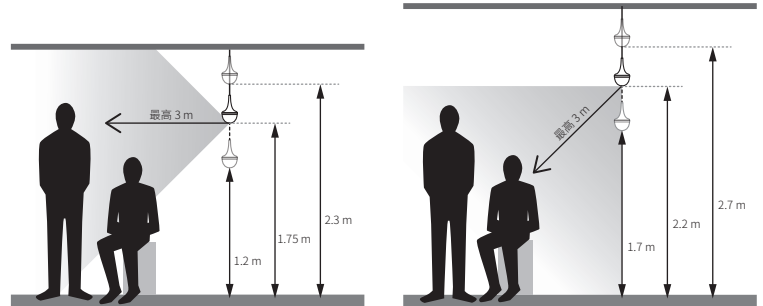

■ 覆蓋範例

- 若為 360° 覆蓋，請在 0°、90°、180°、270° 位置建立四個超心形 (正常) 虛擬指向特性。此設置非常適合提供圓桌四個人的全指向覆蓋 (請見圖A)。
- 若為 300° 覆蓋，請在 0°、90°、180° 位置建立三個心形 (寬廣) 虛擬指向特性。此設定非常適合覆蓋方形桌邊的三個人 (請見圖B)。

圖 A





圖 B

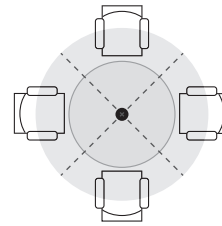
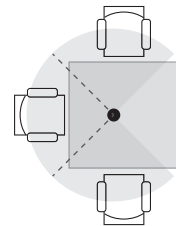

■ 將本產品搭配 ATDM-0604 數位SMART MIX™使用

如需 ATDM-0604 的韌體，請使用 1.1.0 以上版本。

1. 將本產品的 Mic 1-4 連接至 ATDM-0604 的輸入 1-4。啟動 ATDM-0604 Web Remote，選擇「Administrator」並登入。
2. 按一下畫面右上角的  圖示，然後選擇聲音>聲音系統。啟用「Virtual Mic Mode」。如此會將 ATDM-0604 的前 4 個通道，自動轉換為從本產品輸入所建立的虛擬指向特性。

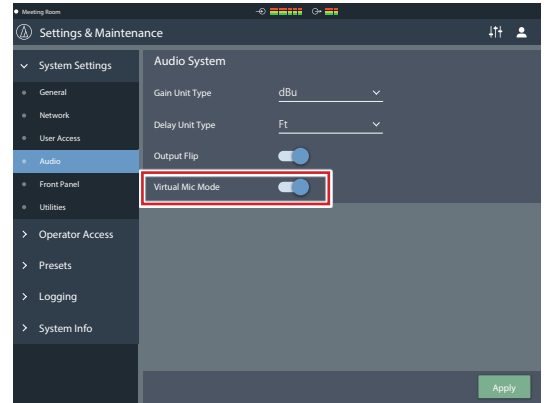

■ 設定和維護中的操作者存取／操作者頁面

啟用「Virtual Mic Mode」後，會有一個選項用於顯示或隱藏操作者頁面中的「Array Mic Off」按鈕。此按鈕允許操作者關閉麥克風，並從操作者頁面關閉 LED 環形燈，以暫時靜音。

- 此設定不會儲存在裝置上，因此重新開機時，ATDM-0604 會將其恢復為預設的「Mic On」位置。

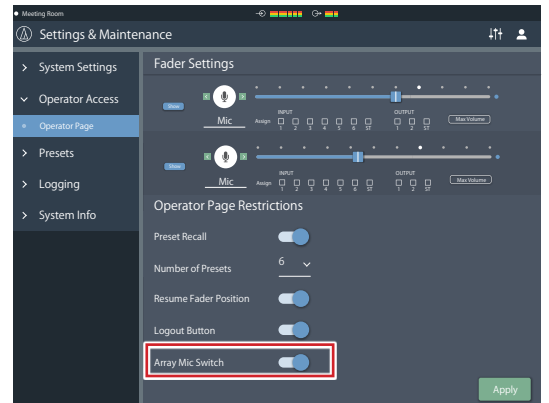







■ 在管理員主頁面中，按一下輸入索引標籤

1. 將前 4 個通道的輸入切換為虛擬麥克風。
2. 將增益調整到所需的電平。(a)
 - 設定單一通道上的輸入增益時，會同時更改其在所有四個通道上的值。您可以分別為每個通道或「Virtual Mic」指定高通濾波、EQ、智慧混合和路由。
3. 按一下虛擬麥克風方塊 (b) 的一側可開啟指向性部分的設定索引標籤。您可以在「Normal」(超心形)、「Wide」(心形) 和「Omni」之間調整這些設定值。
4. 按一下圓圈周圍的藍色按鈕可設定每個虛擬麥克風的方向。
5. 將虛擬麥克風方向調往拾音來源。
 - 「鐵三角」標誌位於麥克風的前面。麥克風必須正確定向才能正常運作。
6. 您可以使用「Tilt」功能，根據講者是坐姿還是站姿，調整垂直平面上的指向性來調整角度。
7. 使用音量推桿調整每個虛擬麥克風的個別音量。

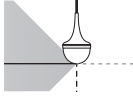
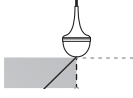
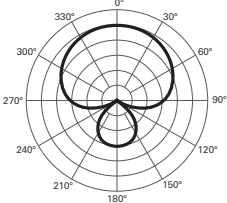

■ 搭配其他相容混音器使用

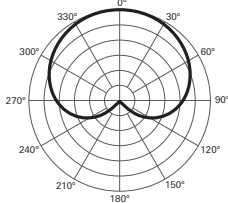
使用非 ATDM-0604 的混音器連接和搭配本產品時，可遵照以下混音矩陣，透過調整每個通道的輸出來控制指向性。

混音矩陣	正常 	寬廣 																																																																																																																																																																																																																																																									
<p>向上傾斜 </p> <table border="1"> <thead> <tr> <th rowspan="2">指向性方向</th> <th colspan="2">O</th> <th colspan="2">L</th> <th colspan="2">R</th> <th colspan="2">Z</th> </tr> <tr> <th>φ</th> <th>電平</th> <th>φ</th> <th>電平</th> <th>φ</th> <th>電平</th> <th>φ</th> <th>電平</th> </tr> </thead> <tbody> <tr><td>0°</td><td>+</td><td>-4dB</td><td>-</td><td>0dB</td><td>-</td><td>0dB</td><td></td><td>-∞</td></tr> <tr><td>30°</td><td>+</td><td>-4dB</td><td>-</td><td>+1.2dB</td><td>-</td><td>-4.8dB</td><td></td><td>-∞</td></tr> <tr><td>60°</td><td>+</td><td>-4dB</td><td>-</td><td>0dB</td><td></td><td>-∞</td><td></td><td>-∞</td></tr> <tr><td>90°</td><td>+</td><td>-4dB</td><td>-</td><td>-4.8dB</td><td>+</td><td>-4.8dB</td><td></td><td>-∞</td></tr> <tr><td>120°</td><td>+</td><td>-4dB</td><td></td><td>-∞</td><td>+</td><td>0dB</td><td></td><td>-∞</td></tr> <tr><td>150°</td><td>+</td><td>-4dB</td><td>+</td><td>-4.8dB</td><td>+</td><td>+1.2dB</td><td></td><td>-∞</td></tr> <tr><td>180°</td><td>+</td><td>-4dB</td><td>+</td><td>0dB</td><td>+</td><td>0dB</td><td></td><td>-∞</td></tr> <tr><td>210°</td><td>+</td><td>-4dB</td><td>+</td><td>+1.2dB</td><td>+</td><td>-4.8dB</td><td></td><td>-∞</td></tr> <tr><td>240°</td><td>+</td><td>-4dB</td><td>+</td><td>0dB</td><td></td><td>-∞</td><td></td><td>-∞</td></tr> <tr><td>270°</td><td>+</td><td>-4dB</td><td>+</td><td>-4.8dB</td><td>-</td><td>-4.8dB</td><td></td><td>-∞</td></tr> <tr><td>300°</td><td>+</td><td>-4dB</td><td></td><td>-∞</td><td>-</td><td>0dB</td><td></td><td>-∞</td></tr> <tr><td>330°</td><td>+</td><td>-4dB</td><td>-</td><td>-4.8dB</td><td>-</td><td>+1.2dB</td><td></td><td>-∞</td></tr> </tbody> </table>	指向性方向	O		L		R		Z		φ	電平	φ	電平	φ	電平	φ	電平	0°	+	-4dB	-	0dB	-	0dB		-∞	30°	+	-4dB	-	+1.2dB	-	-4.8dB		-∞	60°	+	-4dB	-	0dB		-∞		-∞	90°	+	-4dB	-	-4.8dB	+	-4.8dB		-∞	120°	+	-4dB		-∞	+	0dB		-∞	150°	+	-4dB	+	-4.8dB	+	+1.2dB		-∞	180°	+	-4dB	+	0dB	+	0dB		-∞	210°	+	-4dB	+	+1.2dB	+	-4.8dB		-∞	240°	+	-4dB	+	0dB		-∞		-∞	270°	+	-4dB	+	-4.8dB	-	-4.8dB		-∞	300°	+	-4dB		-∞	-	0dB		-∞	330°	+	-4dB	-	-4.8dB	-	+1.2dB		-∞	<table border="1"> <thead> <tr> <th rowspan="2">指向性方向</th> <th colspan="2">O</th> <th colspan="2">L</th> <th colspan="2">R</th> <th colspan="2">Z</th> </tr> <tr> <th>φ</th> <th>電平</th> <th>φ</th> <th>電平</th> <th>φ</th> <th>電平</th> <th>φ</th> <th>電平</th> </tr> </thead> <tbody> <tr><td>0°</td><td>+</td><td>0dB</td><td>-</td><td>0dB</td><td>-</td><td>0dB</td><td></td><td>-∞</td></tr> <tr><td>30°</td><td>+</td><td>0dB</td><td>-</td><td>+1.2dB</td><td>-</td><td>-4.8dB</td><td></td><td>-∞</td></tr> <tr><td>60°</td><td>+</td><td>0dB</td><td>-</td><td>0dB</td><td></td><td>-∞</td><td></td><td>-∞</td></tr> <tr><td>90°</td><td>+</td><td>0dB</td><td>-</td><td>-4.8dB</td><td>+</td><td>-4.8dB</td><td></td><td>-∞</td></tr> <tr><td>120°</td><td>+</td><td>0dB</td><td></td><td>-∞</td><td>+</td><td>0dB</td><td></td><td>-∞</td></tr> <tr><td>150°</td><td>+</td><td>0dB</td><td>+</td><td>-4.8dB</td><td>+</td><td>+1.2dB</td><td></td><td>-∞</td></tr> <tr><td>180°</td><td>+</td><td>0dB</td><td>+</td><td>0dB</td><td>+</td><td>0dB</td><td></td><td>-∞</td></tr> <tr><td>210°</td><td>+</td><td>0dB</td><td>+</td><td>+1.2dB</td><td>+</td><td>-4.8dB</td><td></td><td>-∞</td></tr> <tr><td>240°</td><td>+</td><td>0dB</td><td>+</td><td>0dB</td><td></td><td>-∞</td><td></td><td>-∞</td></tr> <tr><td>270°</td><td>+</td><td>0dB</td><td>+</td><td>-4.8dB</td><td>-</td><td>-4.8dB</td><td></td><td>-∞</td></tr> <tr><td>300°</td><td>+</td><td>0dB</td><td></td><td>-∞</td><td>-</td><td>0dB</td><td></td><td>-∞</td></tr> <tr><td>330°</td><td>+</td><td>0dB</td><td>-</td><td>-4.8dB</td><td>-</td><td>+1.2dB</td><td></td><td>-∞</td></tr> </tbody> </table>	指向性方向	O		L		R		Z		φ	電平	φ	電平	φ	電平	φ	電平	0°	+	0dB	-	0dB	-	0dB		-∞	30°	+	0dB	-	+1.2dB	-	-4.8dB		-∞	60°	+	0dB	-	0dB		-∞		-∞	90°	+	0dB	-	-4.8dB	+	-4.8dB		-∞	120°	+	0dB		-∞	+	0dB		-∞	150°	+	0dB	+	-4.8dB	+	+1.2dB		-∞	180°	+	0dB	+	0dB	+	0dB		-∞	210°	+	0dB	+	+1.2dB	+	-4.8dB		-∞	240°	+	0dB	+	0dB		-∞		-∞	270°	+	0dB	+	-4.8dB	-	-4.8dB		-∞	300°	+	0dB		-∞	-	0dB		-∞	330°	+	0dB	-	-4.8dB	-	+1.2dB		-∞
指向性方向		O		L		R		Z																																																																																																																																																																																																																																																			
	φ	電平	φ	電平	φ	電平	φ	電平																																																																																																																																																																																																																																																			
0°	+	-4dB	-	0dB	-	0dB		-∞																																																																																																																																																																																																																																																			
30°	+	-4dB	-	+1.2dB	-	-4.8dB		-∞																																																																																																																																																																																																																																																			
60°	+	-4dB	-	0dB		-∞		-∞																																																																																																																																																																																																																																																			
90°	+	-4dB	-	-4.8dB	+	-4.8dB		-∞																																																																																																																																																																																																																																																			
120°	+	-4dB		-∞	+	0dB		-∞																																																																																																																																																																																																																																																			
150°	+	-4dB	+	-4.8dB	+	+1.2dB		-∞																																																																																																																																																																																																																																																			
180°	+	-4dB	+	0dB	+	0dB		-∞																																																																																																																																																																																																																																																			
210°	+	-4dB	+	+1.2dB	+	-4.8dB		-∞																																																																																																																																																																																																																																																			
240°	+	-4dB	+	0dB		-∞		-∞																																																																																																																																																																																																																																																			
270°	+	-4dB	+	-4.8dB	-	-4.8dB		-∞																																																																																																																																																																																																																																																			
300°	+	-4dB		-∞	-	0dB		-∞																																																																																																																																																																																																																																																			
330°	+	-4dB	-	-4.8dB	-	+1.2dB		-∞																																																																																																																																																																																																																																																			
指向性方向	O		L		R		Z																																																																																																																																																																																																																																																				
	φ	電平	φ	電平	φ	電平	φ	電平																																																																																																																																																																																																																																																			
0°	+	0dB	-	0dB	-	0dB		-∞																																																																																																																																																																																																																																																			
30°	+	0dB	-	+1.2dB	-	-4.8dB		-∞																																																																																																																																																																																																																																																			
60°	+	0dB	-	0dB		-∞		-∞																																																																																																																																																																																																																																																			
90°	+	0dB	-	-4.8dB	+	-4.8dB		-∞																																																																																																																																																																																																																																																			
120°	+	0dB		-∞	+	0dB		-∞																																																																																																																																																																																																																																																			
150°	+	0dB	+	-4.8dB	+	+1.2dB		-∞																																																																																																																																																																																																																																																			
180°	+	0dB	+	0dB	+	0dB		-∞																																																																																																																																																																																																																																																			
210°	+	0dB	+	+1.2dB	+	-4.8dB		-∞																																																																																																																																																																																																																																																			
240°	+	0dB	+	0dB		-∞		-∞																																																																																																																																																																																																																																																			
270°	+	0dB	+	-4.8dB	-	-4.8dB		-∞																																																																																																																																																																																																																																																			
300°	+	0dB		-∞	-	0dB		-∞																																																																																																																																																																																																																																																			
330°	+	0dB	-	-4.8dB	-	+1.2dB		-∞																																																																																																																																																																																																																																																			
<p>向下傾斜 </p> <table border="1"> <thead> <tr> <th rowspan="2">指向性方向</th> <th colspan="2">O</th> <th colspan="2">L</th> <th colspan="2">R</th> <th colspan="2">Z</th> </tr> <tr> <th>φ</th> <th>電平</th> <th>φ</th> <th>電平</th> <th>φ</th> <th>電平</th> <th>φ</th> <th>電平</th> </tr> </thead> <tbody> <tr><td>0°</td><td>+</td><td>-4dB</td><td>-</td><td>-3dB</td><td>-</td><td>-3dB</td><td>+</td><td>-3dB</td></tr> <tr><td>30°</td><td>+</td><td>-4dB</td><td>-</td><td>-1.8dB</td><td>-</td><td>-7.8dB</td><td>+</td><td>-3dB</td></tr> <tr><td>60°</td><td>+</td><td>-4dB</td><td>-</td><td>0dB</td><td></td><td>-∞</td><td>+</td><td>-3dB</td></tr> <tr><td>90°</td><td>+</td><td>-4dB</td><td>-</td><td>-7.8dB</td><td>+</td><td>-7.8dB</td><td>+</td><td>-3dB</td></tr> <tr><td>120°</td><td>+</td><td>-4dB</td><td></td><td>-∞</td><td>+</td><td>0dB</td><td>+</td><td>-3dB</td></tr> <tr><td>150°</td><td>+</td><td>-4dB</td><td>+</td><td>-7.8dB</td><td>+</td><td>-1.8dB</td><td>+</td><td>-3dB</td></tr> <tr><td>180°</td><td>+</td><td>-4dB</td><td>+</td><td>0dB</td><td>+</td><td>0dB</td><td>+</td><td>-3dB</td></tr> <tr><td>210°</td><td>+</td><td>-4dB</td><td>+</td><td>-1.8dB</td><td>+</td><td>-7.8dB</td><td>+</td><td>-3dB</td></tr> <tr><td>240°</td><td>+</td><td>-4dB</td><td>+</td><td>0dB</td><td></td><td>-∞</td><td>+</td><td>-3dB</td></tr> <tr><td>270°</td><td>+</td><td>-4dB</td><td>+</td><td>-7.8dB</td><td>-</td><td>-7.8dB</td><td>+</td><td>-3dB</td></tr> <tr><td>300°</td><td>+</td><td>-4dB</td><td></td><td>-∞</td><td>-</td><td>0dB</td><td>+</td><td>-3dB</td></tr> <tr><td>330°</td><td>+</td><td>-4dB</td><td>-</td><td>-7.8dB</td><td>-</td><td>-1.8dB</td><td>+</td><td>-3dB</td></tr> </tbody> </table>	指向性方向	O		L		R		Z		φ	電平	φ	電平	φ	電平	φ	電平	0°	+	-4dB	-	-3dB	-	-3dB	+	-3dB	30°	+	-4dB	-	-1.8dB	-	-7.8dB	+	-3dB	60°	+	-4dB	-	0dB		-∞	+	-3dB	90°	+	-4dB	-	-7.8dB	+	-7.8dB	+	-3dB	120°	+	-4dB		-∞	+	0dB	+	-3dB	150°	+	-4dB	+	-7.8dB	+	-1.8dB	+	-3dB	180°	+	-4dB	+	0dB	+	0dB	+	-3dB	210°	+	-4dB	+	-1.8dB	+	-7.8dB	+	-3dB	240°	+	-4dB	+	0dB		-∞	+	-3dB	270°	+	-4dB	+	-7.8dB	-	-7.8dB	+	-3dB	300°	+	-4dB		-∞	-	0dB	+	-3dB	330°	+	-4dB	-	-7.8dB	-	-1.8dB	+	-3dB	<table border="1"> <thead> <tr> <th rowspan="2">指向性方向</th> <th colspan="2">O</th> <th colspan="2">L</th> <th colspan="2">R</th> <th colspan="2">Z</th> </tr> <tr> <th>φ</th> <th>電平</th> <th>φ</th> <th>電平</th> <th>φ</th> <th>電平</th> <th>φ</th> <th>電平</th> </tr> </thead> <tbody> <tr><td>0°</td><td>+</td><td>0dB</td><td>-</td><td>-3dB</td><td>-</td><td>-3dB</td><td>+</td><td>-3dB</td></tr> <tr><td>30°</td><td>+</td><td>0dB</td><td>-</td><td>-1.8dB</td><td>-</td><td>-7.8dB</td><td>+</td><td>-3dB</td></tr> <tr><td>60°</td><td>+</td><td>0dB</td><td>-</td><td>0dB</td><td></td><td>-∞</td><td>+</td><td>-3dB</td></tr> <tr><td>90°</td><td>+</td><td>0dB</td><td>-</td><td>-7.8dB</td><td>+</td><td>-7.8dB</td><td>+</td><td>-3dB</td></tr> <tr><td>120°</td><td>+</td><td>0dB</td><td></td><td>-∞</td><td>+</td><td>0dB</td><td>+</td><td>-3dB</td></tr> <tr><td>150°</td><td>+</td><td>0dB</td><td>+</td><td>-7.8dB</td><td>+</td><td>-1.8dB</td><td>+</td><td>-3dB</td></tr> <tr><td>180°</td><td>+</td><td>0dB</td><td>+</td><td>0dB</td><td>+</td><td>0dB</td><td>+</td><td>-3dB</td></tr> <tr><td>210°</td><td>+</td><td>0dB</td><td>+</td><td>-1.8dB</td><td>+</td><td>-7.8dB</td><td>+</td><td>-3dB</td></tr> <tr><td>240°</td><td>+</td><td>0dB</td><td>+</td><td>0dB</td><td></td><td>-∞</td><td>+</td><td>-3dB</td></tr> <tr><td>270°</td><td>+</td><td>0dB</td><td>+</td><td>-7.8dB</td><td>-</td><td>-7.8dB</td><td>+</td><td>-3dB</td></tr> <tr><td>300°</td><td>+</td><td>0dB</td><td></td><td>-∞</td><td>-</td><td>0dB</td><td>+</td><td>-3dB</td></tr> <tr><td>330°</td><td>+</td><td>0dB</td><td>-</td><td>-7.8dB</td><td>-</td><td>-1.8dB</td><td>+</td><td>-3dB</td></tr> </tbody> </table>	指向性方向	O		L		R		Z		φ	電平	φ	電平	φ	電平	φ	電平	0°	+	0dB	-	-3dB	-	-3dB	+	-3dB	30°	+	0dB	-	-1.8dB	-	-7.8dB	+	-3dB	60°	+	0dB	-	0dB		-∞	+	-3dB	90°	+	0dB	-	-7.8dB	+	-7.8dB	+	-3dB	120°	+	0dB		-∞	+	0dB	+	-3dB	150°	+	0dB	+	-7.8dB	+	-1.8dB	+	-3dB	180°	+	0dB	+	0dB	+	0dB	+	-3dB	210°	+	0dB	+	-1.8dB	+	-7.8dB	+	-3dB	240°	+	0dB	+	0dB		-∞	+	-3dB	270°	+	0dB	+	-7.8dB	-	-7.8dB	+	-3dB	300°	+	0dB		-∞	-	0dB	+	-3dB	330°	+	0dB	-	-7.8dB	-	-1.8dB	+	-3dB
指向性方向		O		L		R		Z																																																																																																																																																																																																																																																			
	φ	電平	φ	電平	φ	電平	φ	電平																																																																																																																																																																																																																																																			
0°	+	-4dB	-	-3dB	-	-3dB	+	-3dB																																																																																																																																																																																																																																																			
30°	+	-4dB	-	-1.8dB	-	-7.8dB	+	-3dB																																																																																																																																																																																																																																																			
60°	+	-4dB	-	0dB		-∞	+	-3dB																																																																																																																																																																																																																																																			
90°	+	-4dB	-	-7.8dB	+	-7.8dB	+	-3dB																																																																																																																																																																																																																																																			
120°	+	-4dB		-∞	+	0dB	+	-3dB																																																																																																																																																																																																																																																			
150°	+	-4dB	+	-7.8dB	+	-1.8dB	+	-3dB																																																																																																																																																																																																																																																			
180°	+	-4dB	+	0dB	+	0dB	+	-3dB																																																																																																																																																																																																																																																			
210°	+	-4dB	+	-1.8dB	+	-7.8dB	+	-3dB																																																																																																																																																																																																																																																			
240°	+	-4dB	+	0dB		-∞	+	-3dB																																																																																																																																																																																																																																																			
270°	+	-4dB	+	-7.8dB	-	-7.8dB	+	-3dB																																																																																																																																																																																																																																																			
300°	+	-4dB		-∞	-	0dB	+	-3dB																																																																																																																																																																																																																																																			
330°	+	-4dB	-	-7.8dB	-	-1.8dB	+	-3dB																																																																																																																																																																																																																																																			
指向性方向	O		L		R		Z																																																																																																																																																																																																																																																				
	φ	電平	φ	電平	φ	電平	φ	電平																																																																																																																																																																																																																																																			
0°	+	0dB	-	-3dB	-	-3dB	+	-3dB																																																																																																																																																																																																																																																			
30°	+	0dB	-	-1.8dB	-	-7.8dB	+	-3dB																																																																																																																																																																																																																																																			
60°	+	0dB	-	0dB		-∞	+	-3dB																																																																																																																																																																																																																																																			
90°	+	0dB	-	-7.8dB	+	-7.8dB	+	-3dB																																																																																																																																																																																																																																																			
120°	+	0dB		-∞	+	0dB	+	-3dB																																																																																																																																																																																																																																																			
150°	+	0dB	+	-7.8dB	+	-1.8dB	+	-3dB																																																																																																																																																																																																																																																			
180°	+	0dB	+	0dB	+	0dB	+	-3dB																																																																																																																																																																																																																																																			
210°	+	0dB	+	-1.8dB	+	-7.8dB	+	-3dB																																																																																																																																																																																																																																																			
240°	+	0dB	+	0dB		-∞	+	-3dB																																																																																																																																																																																																																																																			
270°	+	0dB	+	-7.8dB	-	-7.8dB	+	-3dB																																																																																																																																																																																																																																																			
300°	+	0dB		-∞	-	0dB	+	-3dB																																																																																																																																																																																																																																																			
330°	+	0dB	-	-7.8dB	-	-1.8dB	+	-3dB																																																																																																																																																																																																																																																			
<p>指向特性</p>  <p>圖例 1kHz </p> <p>比例尺為每刻度 5 分貝</p>	 <p>圖例 1kHz </p> <p>比例尺為每刻度 5 分貝</p>																																																																																																																																																																																																																																																										

規格

元件	背極式駐極體電容型
指向特性	全指向 (O) / 八字形 (L/R/Z)
頻率響應	20~16,000 Hz
開路感度	O/L/R: -36 dB (15.85 mV) (0 dB=1 V/Pa, 1 kHz); Z: -38.5 dB (11.9 mV) (0 dB=1 V/Pa, 1 kHz)
阻抗	100歐姆
最大承受音壓位準	O/L/R: 132.5 dB SPL (1 kHz THD1%); Z: 135 dB SPL (1 kHz THD1%)
訊噪比	O/L/R: 66.5 dB (1 kHz於1 Pa·A型加權) Z: 64 dB (1 kHz於1 Pa·A型加權)
幻象電源	直流 11 - 52 V·23.2 mA (合計兩個通道)
重量	麥克風: 160 g 固定組件盒 (AT8554): 420 g
外型尺寸 (麥克風)	最大機身直徑: 61.6 mm; 高: 111.8 mm
(天花板固定組件 (AT8554))	36.6 mm × 106.0 mm × 106.0 mm (H×W×D)
輸出端子	Euroblock 接頭
配件	天花板固定組件 (AT8554)、RJ45 分接纜線 × 2、 抗震纜線、吸震墊

· 1 帕斯卡 = 10 達因 / 平方公分 = 10 微巴 = 94 dB SPL
規格若有改良，請恕不另行通知。

指向特性 / 頻率響應

全指向 (O)

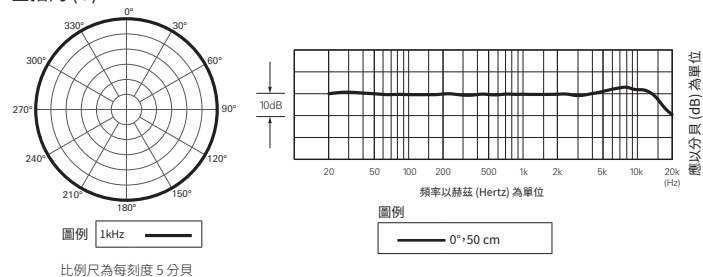

八字形 (L/R/Z)

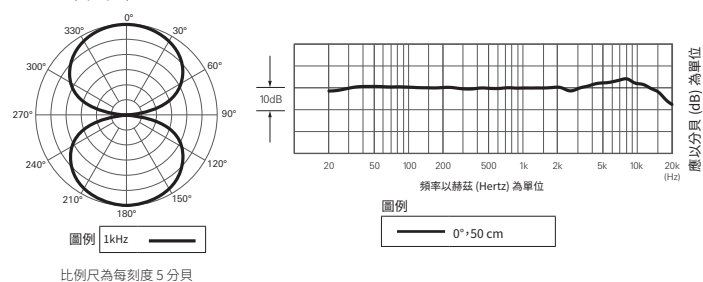

外型尺寸

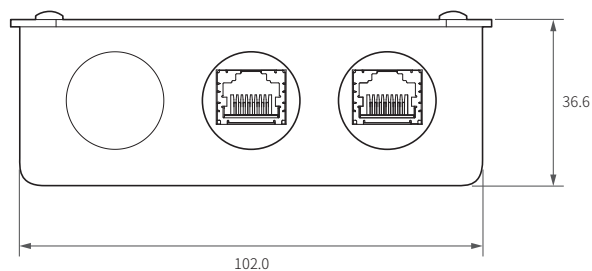
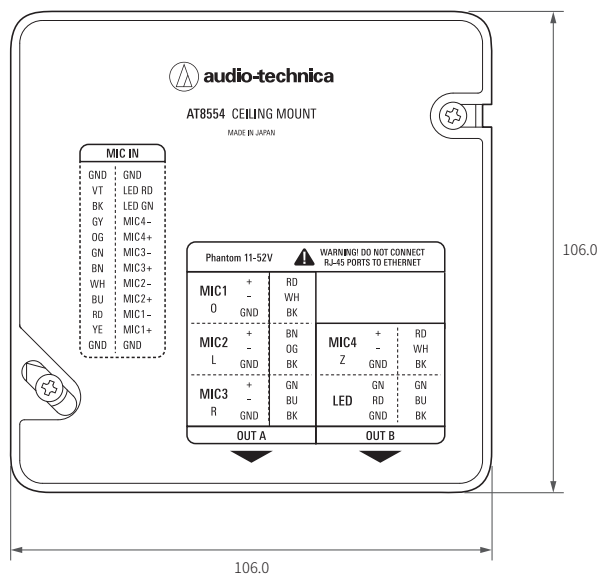
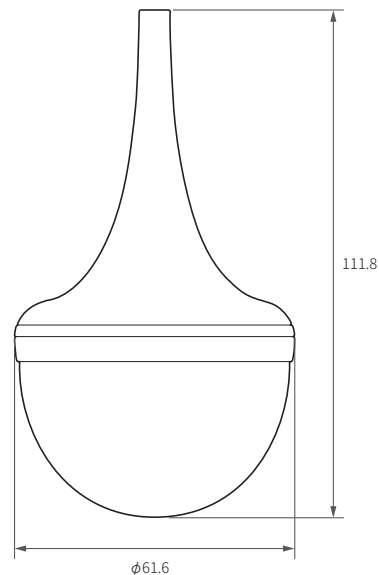

(單位：mm)