

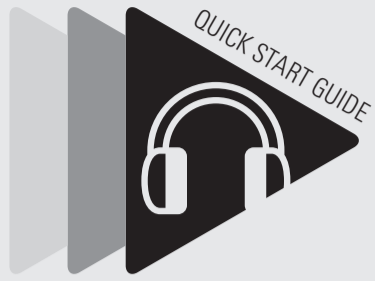

audio-technica



### Check / はじめに確認

- Headphones / 製品本体
- Cable (1.2 m (3.9')) / コード (1.2m)
- USB charging cable / 充電用USBケーブル
- Pouch / ポーチ
- Quick start guide (this leaflet) / クイックスタートガイド (本書)
- Caution guide / 取扱注意ガイド

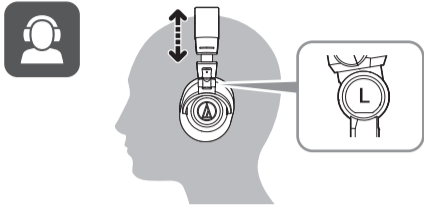

ATH-M50xBT

### Pairing / ペアリング

1

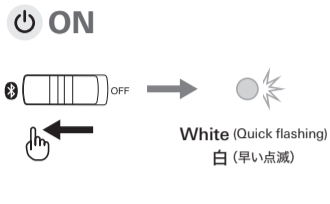

2



3

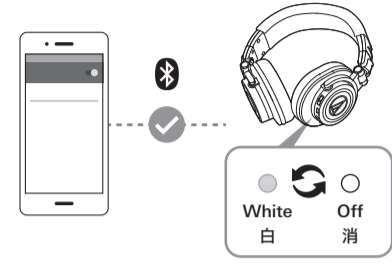

### Music/Phone / 聴く/通話

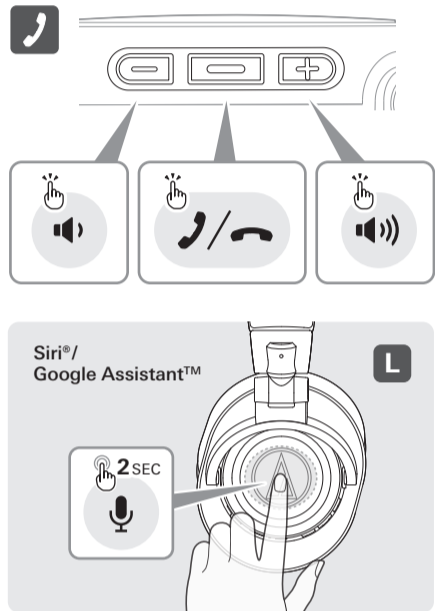
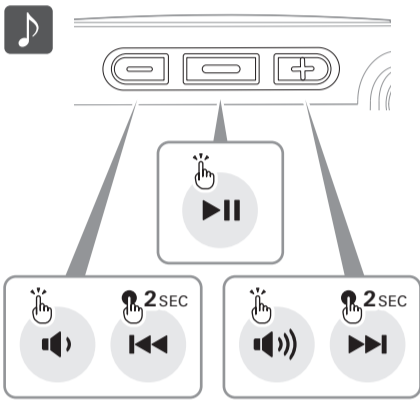

### Charge / 充電

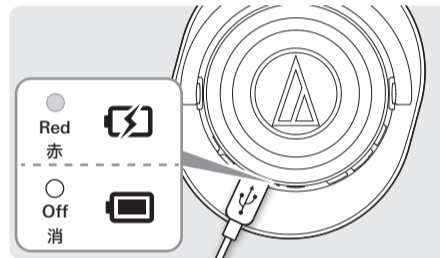
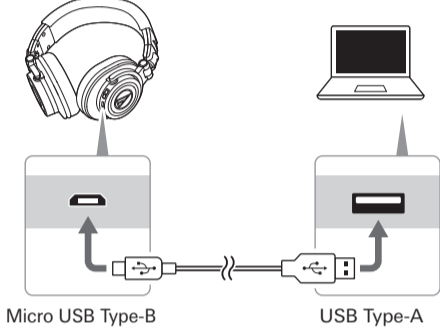

### Information / ご案内

For more information on how to use this product, visit the Audio-Technica website at the URL listed below and contained in the QR code.

www.audio-technica.com

To more conveniently use the product, use our app for smartphone.

当社のスマートフォン用アプリをご利用いただくと、本製品をより便利にお使いいただけます。

Download on the App Store

GET IT ON Google Play

本製品の使いかたを詳しく知りたい場合は、QRコードからアクセスいただけます。

The Bluetooth® word mark and logos are owned by Bluetooth SIG, Inc. and any use of such marks by Audio-Technica Corporation is under license. All other trademarks are property of their respective owners.

Apple, the Apple logo and Siri are trademarks of Apple Inc., registered in the U.S. and other countries.

App Store is a service mark of Apple Inc.

Google Play, the Google Play logo and Google Assistant are trademarks of Google LLC.

株式会社オーディオテクニカ  
〒194-8666 東京都町田市西成瀬2-46-1  
Audio-Technica Corporation  
2-46-1 Nishi-naruse, Machida, Tokyo 194-8666, Japan  
www.audio-technica.co.jp ver.1 2018.07.15  
©2018 Audio-Technica Corporation 132416590-01-03 ver.3 2018.09.01

Français / Deutsch / Italiano

### Contrôle / Kontrolle / Controllo

- Casque / Kopfhörer / Cuffie
- Câble (1,2 m) / Kabel (1,2 m) / Cavo (1,2 m)
- Câble de recharge USB / USB-Ladekabel / Cavo per la carica USB
- Pochette de protection / Tasche / Sacca
- Guide de prise en main (ce dépliant) / Kurzanleitung (dieser Handzettel) / Guida rapida (questo opuscolo)
- Guide de mise en garde / Sicherheitsanweisungen / Guida precauzionale

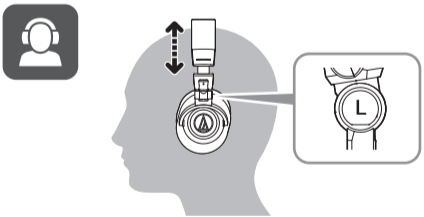

### Appairage / Paarung / Associazione

1

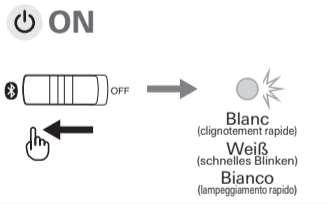

2



3

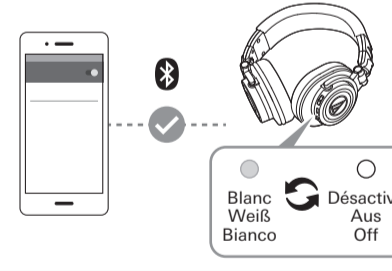

### Musique/Téléphone / Musik/Handy / Musica/Telefono

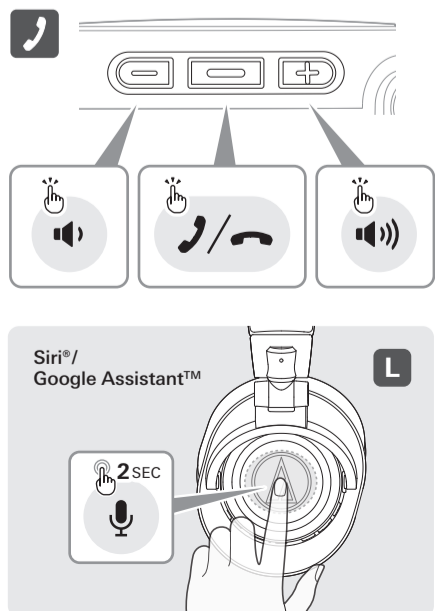
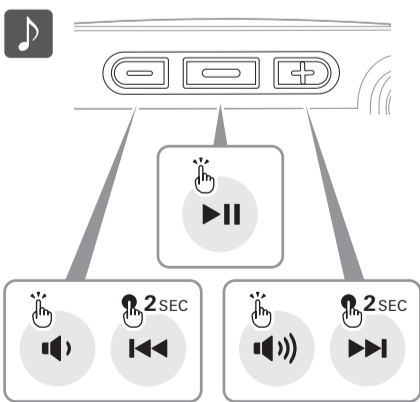

### Charge / Laden / Carica

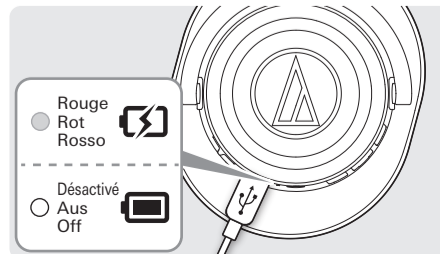
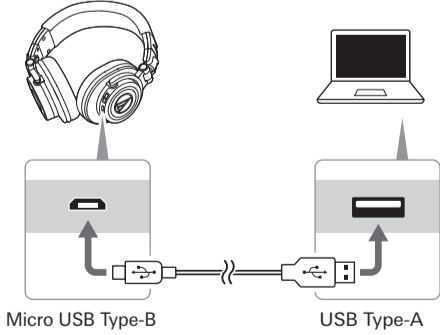

### Informations / Informationen / Informazioni

Pour plus d'information sur les modalités d'utilisation de ce produit, rendez-vous sur le site Web Audio-Technica à l'URL indiquée ci-après et contenue dans le QR code.

Für weitere Informationen zur Nutzung dieses Produkts besuchen Sie die Audio-Technica-Website unter der unten angeführten und der im QR-Code enthaltenen URL.

Per maggiori informazioni su come utilizzare questo prodotto, consultare il sito di Audio-Technica all' URL indicato di seguito incluso nel codice QR.

www.audio-technica.com

Pour utiliser plus facilement ce produit, rendez-vous sur notre application pour smartphones.

Um das Produkt noch besser verwenden zu können, nutzen Sie unsere App für Smartphones.

Per un impiego più versatile del prodotto, utilizzare la app specifica per smartphone.

### ✓ Comprobar / Conteúdo da embalagem / Проверка

- Auriculares / Fones de ouvido / Наушники
- Cable (1,2 m) / Cabo (1,2 m) / Кабель (1,2 м)
- Cable de carga USB / Cabo de carga USB / USB-кабель для зарядки
- Bolsa / Bolsa / Сумка
- Guía de inicio rápido (este folleto) / Guia rápido (este folheto) / Краткое руководство пользователя (этот листок)
- Guía de precauciones / Guia de precauções de segurança / Руководство по мерам предосторожности

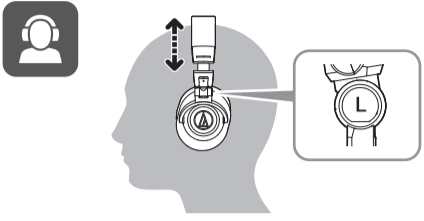

### Emparejamiento / Emparelhamento / Сопряжение

1

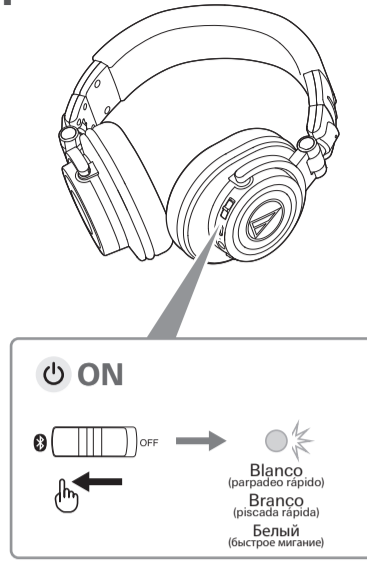

2



3

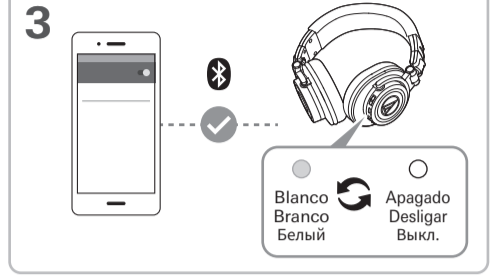

### ♪ Música/Teléfono / Música/Telefone / Музыка/Телефон

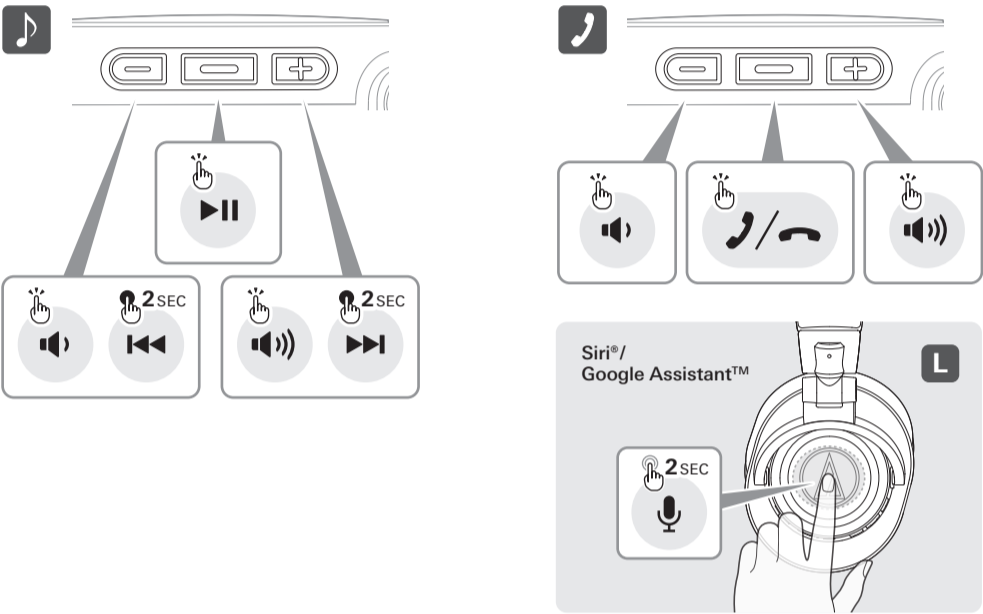

### 🔌 Carga / Carregar / Заряд

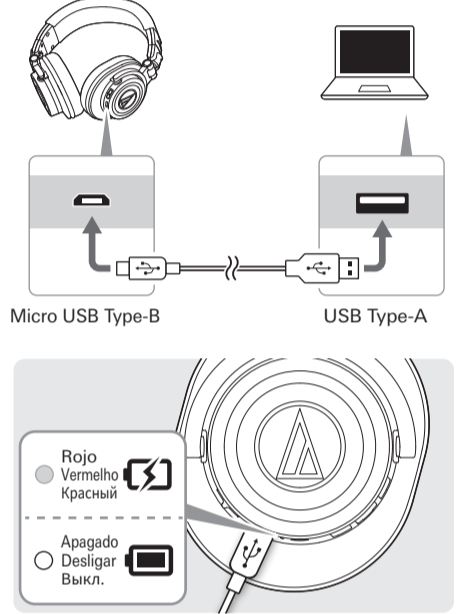

### 📖 Información / Informações / Информация

Para obtener más información sobre cómo usar este producto, visite el sitio web de Audio-Technica en la URL mostrada a continuación e incluida en el código QR.

Para obter mais informações sobre como usar este produto, visite o site da Audio-Technica no endereço listado abaixo e contido no código QR.

Для получения дополнительной информации по использованию этого изделия посетите веб-сайт компании Audio-Technica по адресу, указанному ниже, а также зашифрованному в QR-коде.

[www.audio-technica.com](http://www.audio-technica.com)

Para utilizar con mayor comodidad el producto, utilice nuestra aplicación para smartphones.

Para um uso mais conveniente do produto, use nosso aplicativo para smartphones.

Для более удобного использования изделия воспользуйтесь нашим приложением для смартфонов.

### ✓ 检查 / 検査 / 확인

- 耳机 / 耳機 / 헤드폰
- 连接线 (1.2 m) / 導線 (1.2 m) / 케이블(1.2 m)
- USB充电线 / USB充電線 / USB 충전 케이블
- 收纳袋 / 攜存袋 / 파우치
- 快速入门指南 (本说明书) / 快速入門指南 (本手冊) / 빠른 시작 가이드(본 소책자)
- 注意事项指南 / 注意事項 / 주의사항 안내

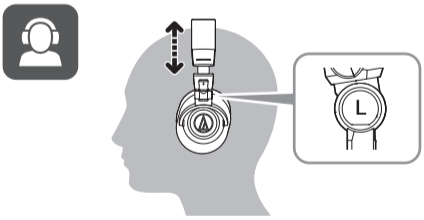

### 📱 配对 / 配對 / 페어링

1

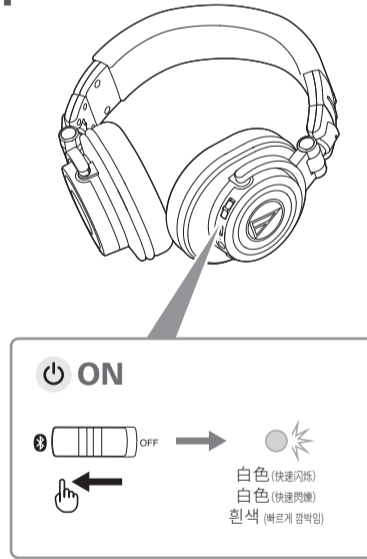

2



3

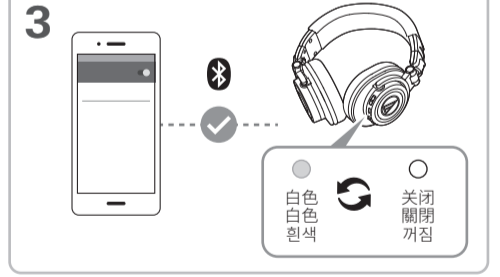

### ♪ 音乐/电话 / 音樂/電話 / 음악/통화

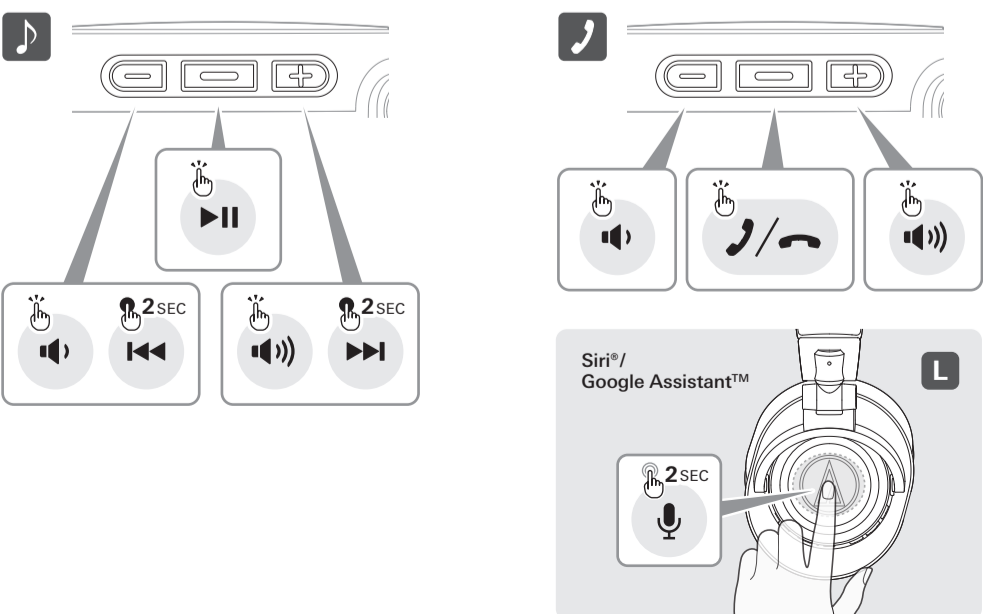

### 🔌 充电 / 充電 / 충전

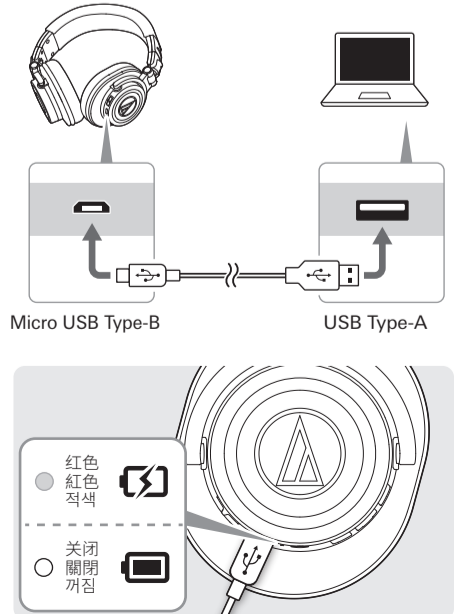

### 📖 信息 / 資訊 / 정보

更多关于如何使用本产品的信息，请通过下列网址或扫描二维码访问“铁三角”网站。

欲獲得本產品的詳細使用方法，請掃描下方 QR code 或直接透過網址連接至「鐵三角」網站。

본 제품의 사용법에 관한 자세한 사항은 아래의 URL과 QR 코드에 있는 Audio-Technica 웹사이트에서 확인할 수 있습니다.

[www.audio-technica.com](http://www.audio-technica.com)

请使用我们的智能手机应用程序，可更方便地使用本产品。

請使用我們的智慧型手機 App，可更方便地使用本產品。

제품을 더욱 편리하게 사용하려면 스마트폰 앱을 사용하십시오.